

PARK LAMPS SYSTEM

PARK LAMPS SYSTEM

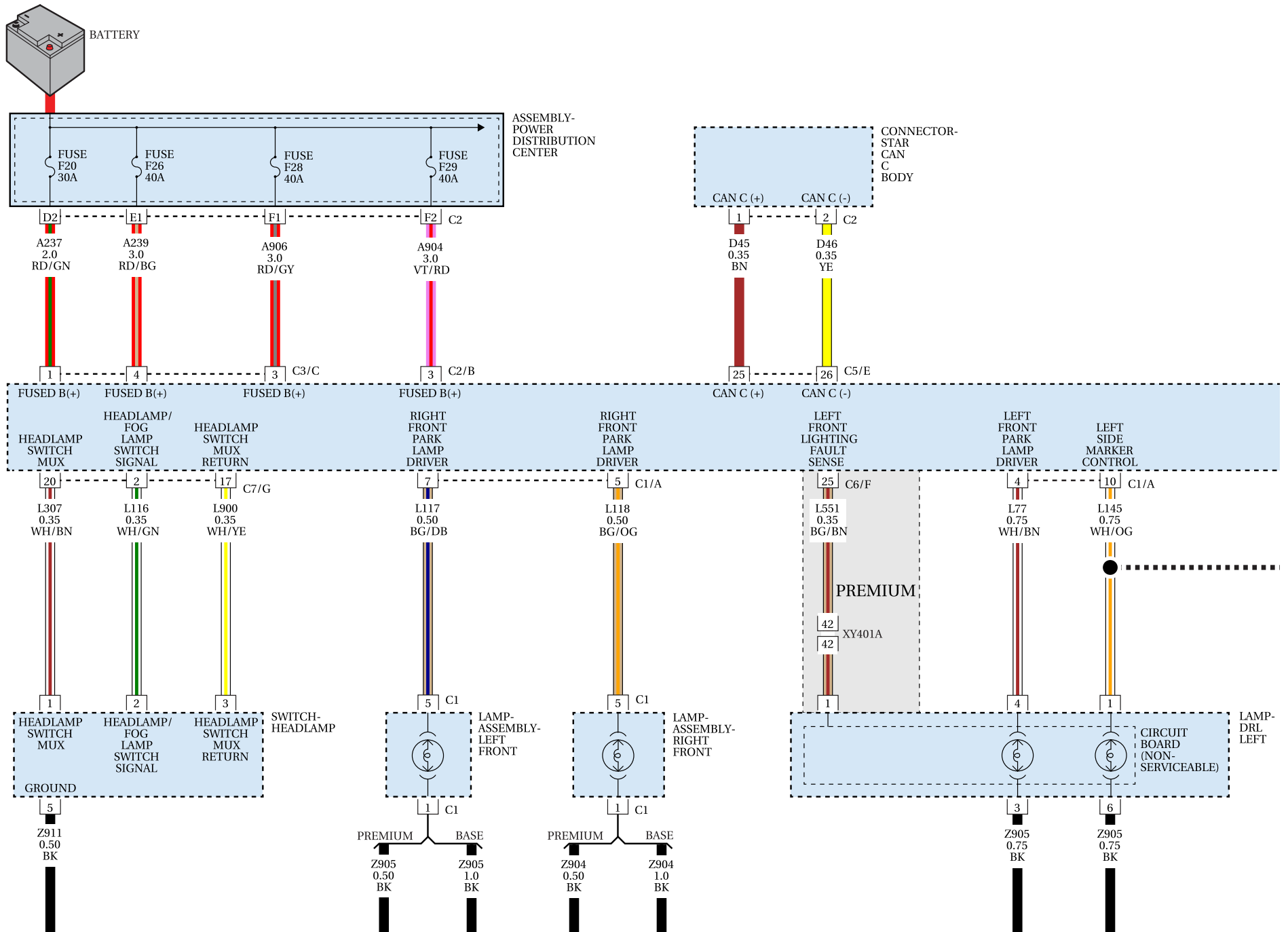

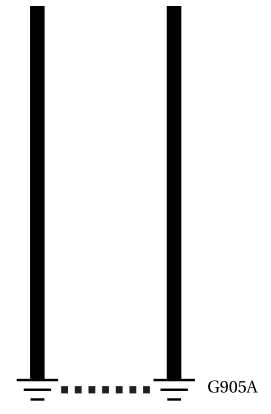
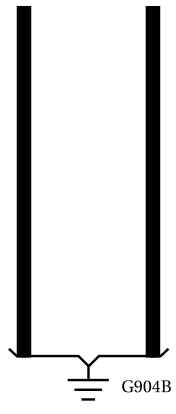
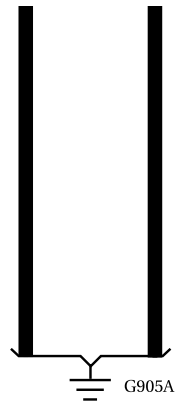

PARK LAMPS SYSTEM

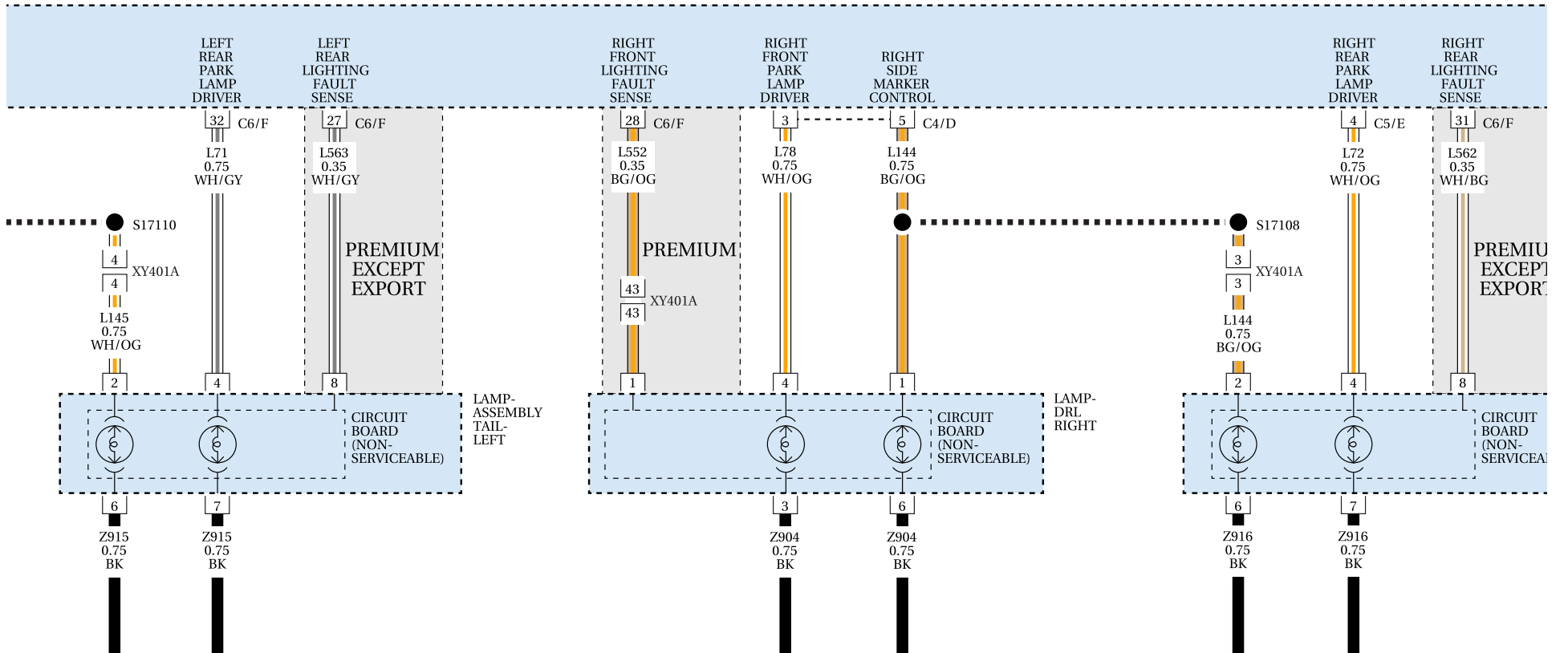

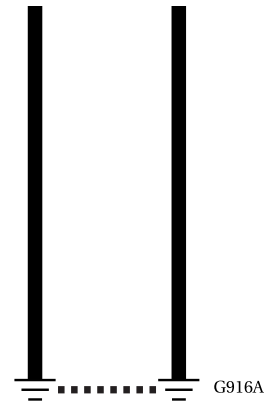
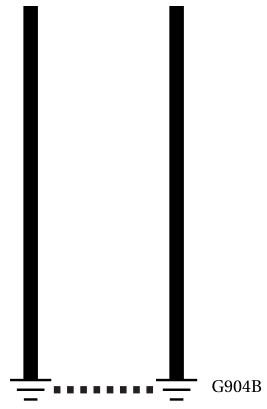
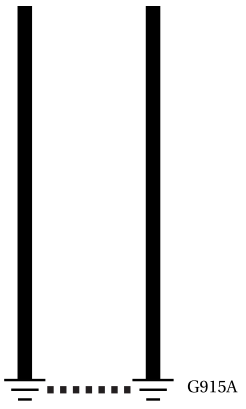

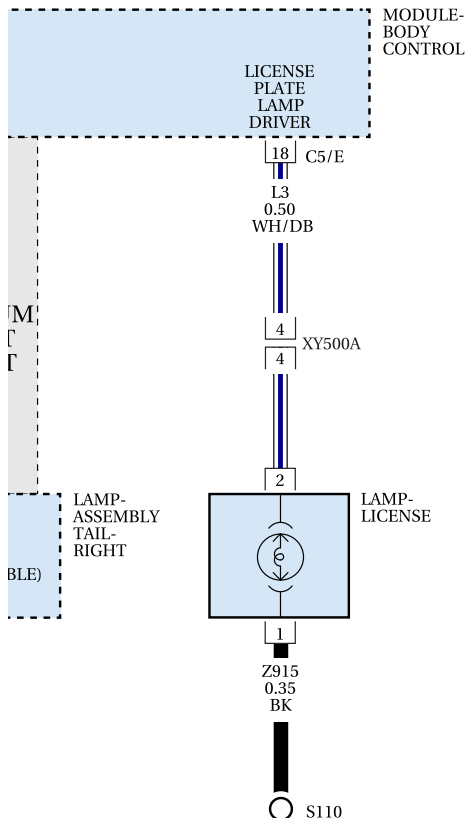

Z915
0.50
BK



8

XY500A

Z915
0.50
BK



G915A